



LTM⁽¹⁾

Line thermal magnetic protection

SMR1

Selective electronic protection.

SMR2

Modular electronic protection with enhanced functionality

Mag Break™

Magnetic Only protection

Y

Non Automatic or switch
(not mentioned in tables)

(1) Consult us for availability

FG Frame

Breaking capacities

Icu 400/415V AC in kA eff.

Type	N	H	L
FG400	50	80	150
FG630	50	80	150

Protection

Trip Unit	Rated Current (A)	SMR1	SMR2	Mag Break™
	A			
FG400	250	N, H, L	N, H, L	N, H, L
	350	N, H, L	N, H, L	N, H, L
	400	N, H, L	N, H, L	-
FG630	400	N, H, L	N, H, L	-
	500	N, H, L	N, H, L	N, H, L
	630	N, H, L	N, H, L	-

Number of poles / protected poles (trips)			
3 pole 3 trips	N, H, L	N, H, L	N, H, L
4 pole 3 trips	N, H, L	N, H, L	N, H, L
4 pole 4 trips	N, H, L	N, H, L	N, H, L
4 pole 3.5 trips (N=50%)	N, H, L	N, H, L	N, H, L

Accessories (main types)

- ① Auxiliary contact left mounted (NO or NC) 1, 2 or 3pcs.
- ② Auxiliary contact right mounted (NO or NC) 1 or 2pcs.
- ③ Bell Alarm thermal magnetic trip unit (NO or NC)
- ③a Bell Alarm electronic trip unit (NO or NC)
- ④ Bell Alarm mechanism (NO or NC)
- ⑤ Shunt or Undervoltage release
- ⑤a Actuator for electronic trip unit.
- ⑥ Operators
 - Rotary Handle
 - Electrical Operator
- ⑦ Bottom mounted RCD (below trip unit)
(Insert indicates Bell alarm contact mounting)
Bottom mounted version is also available.
- ⑧ Plug in or draw out system

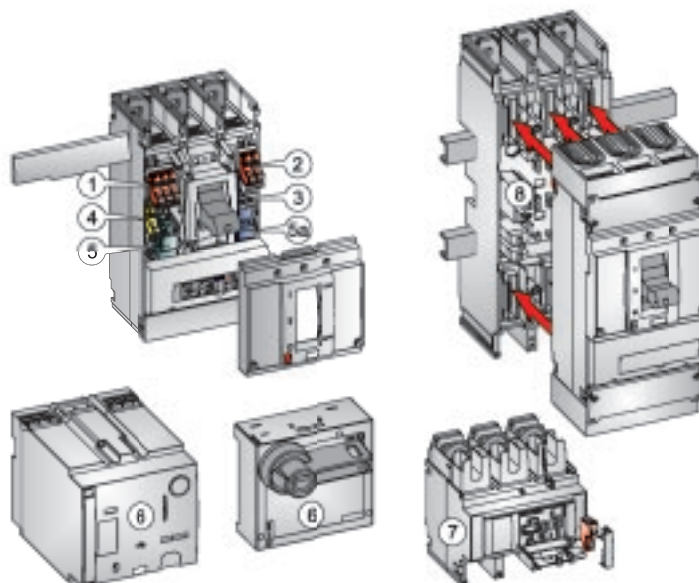

FG400 - Complete Circuit Breaker

Selective Electronic Trip Unit (SMR1) without Rating Plug

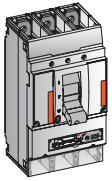
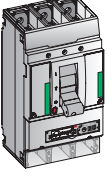
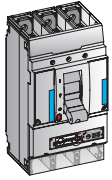

50kA FGN	In (A)	3 pole		4 pole ⁽¹⁾		Cat. nr.	Ref. nr.	Cat. nr.	Ref. nr.
		Cat. nr.	Ref. nr.	Cat. nr.	Ref. nr.				
50kA FGN	250	FGN36AA250LKF	434248	FGN46AA250LKF	434253				
	350	FGN36AA350LLF	434477	FGN46AA350LLF	434507				
	400	FGN36AA400LLF	431455	FGN46AA400LLF	431536				
80kA FGH	250	FGH36AA250LKF	434232	FGH46AA250LKF	434237				
	350	FGH36AA350LLF	434387	FGH46AA350LLF	434417				
	400	FGH36AA400LLF	431032	FGH46AA400LLF	431106				
150kA FGL	250	FGL36AA250LKF	434240	FGL46AA250LKF	434245				
	350	FGL36AA350LLF	434429	FGL46AA350LLF	434465				
	400	FGL36AA400LLF	431246	FGL46AA400LLF	431330				

One code covers: A standard fixed front connection breaker + Assembled trip unit + Toggle Elongator + Breaker finishing covers + Fixation hardware

Type line 0.64 - 1 x In Adjustable Rating Plugs for Trip Units SMR1

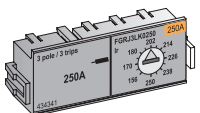

250A	In (A)	3 pole 3 trips		4 pole 3 trips ⁽¹⁾		4 pole 4 trips ⁽¹⁾		4 pole 3.5 trips (N=50%) ⁽¹⁾	
		Cat. nr.	Ref. nr.	Cat. nr.	Ref. nr.	Cat. nr.	Ref. nr.	Cat. nr.	Ref. nr.
250A	160	FGRJ3LK0160	434337	FGRJ43LK0160	434345	FGRJ4LK0160	434361	FGRJ45LK0160	434353
	250	FGRJ3LK0250	434341	FGRJ43LK0250	434349	FGRJ4LK0250	434365	FGRJ45LK0250	434357
	400A	FGRJ3LL0250	435343	FGRJ43LL0250	435356	FGRJ4LL0250	435397	FGRJ45LL0250	435367
400A	400	FGRJ3LL0400	433151	FGRJ43LL0400	433163	FGRJ4LL0400	433187	FGRJ45LL0400	433175

Type line/Motor 0.4 - 1 x In Switchable Rating Plugs for Trip Units SMR1

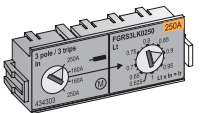

250A	In (A)	3 pole 3 trips		4 pole 3 trips ⁽¹⁾		4 pole 4 trips ⁽¹⁾		4 pole 3.5 trips (N=50%) ⁽¹⁾	
		Cat. nr.	Ref. nr.	Cat. nr.	Ref. nr.	Cat. nr.	Ref. nr.	Cat. nr.	Ref. nr.
250A	250	FGRS3LK0250	434303	FGRS43LK0250	434307	FGRS4LK0250	434315	FGRS45LK0250	434311
	350A	350	FGRS3LL0350	435435	FGRS43LL0350	434516	FGRS4LL0350	434537	FGRS45LL0350

Selective Electronic Trip Unit (SMR1) with switchable Rating Plug

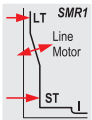
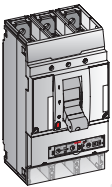

50kA FGN	In (A)	3 pole 3 trips		4 pole 3 trips ⁽¹⁾		4 pole 4 trips ⁽¹⁾		4 pole 3.5 trips (N=50%) ⁽¹⁾	
		Cat. nr.	Ref. nr.	Cat. nr.	Ref. nr.	Cat. nr.	Ref. nr.	Cat. nr.	Ref. nr.
50kA FGN	250	FGN36SA250LKF	434249	FGN436SA250LKF	434251	FGN46SA250LKF	434254	FGN456SA250LKF	434252
	350	FGN36SA350LLF	434489	FGN436SA350LLF	435277	FGN46SA350LLF	435280	FGN456SA350LLF	434504
80kA FGH	250	FGH36SA250LKF	434233	FGH436SA250LKF	434235	FGH46SA250LKF	434238	FGH456SA250LKF	434236
	350	FGH36SA350LLF	434399	FGH436SA350LLF	434408	FGH46SA350LLF	434426	FGH456SA350LLF	434414
150kA FGL	250	FGL36SA250LKF	434241	FGL436SA250LKF	434243	FGL46SA250LKF	434246	FGL456SA250LKF	434244
	350	FGL36SA350LLF	434444	FGL436SA350LLF	434453	FGL46SA350LLF	434474	FGL456SA350LLF	434462

One code covers: A standard fixed front connection breaker + Assembled trip unit + Toggle elongator + Rating plug + Breaker finishing covers + Fixation hardware

Selective Electronic Trip Unit (SMR1) with Rating Plug, without Overload (LT) protection

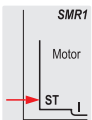
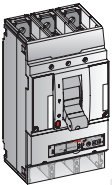

50kA FGN	In (A)	3 pole 3 trips		4 pole 3 trips ⁽¹⁾	
		Cat. nr.	Ref. nr.	Cat. nr.	Ref. nr.
50kA FGN	350	FGN36BM350LLF	434687	FGN436BM350LLF	434693
	80kA FGH	350	FGH36BM350LLF	434663	FGH436BM350LLF
150kA FGL	350	FGL36BM350LLF	434675	FGL436BM350LLF	434681

One code covers: A standard fixed front connection breaker + Assembled trip unit + Toggle elongator + Rating plug + Breaker finishing covers + Fixation hardware

(1) Neutral on the left. If neutral on the right is needed, please contact us.



FG400 - Complete Circuit Breaker

Modular Electronic Trip Unit (SMR2) without Rating Plug

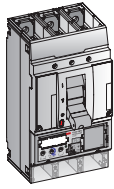

In (A)	3 pole		4 pole ⁽¹⁾		Cat. nr.	Ref. nr.	Cat. nr.	Ref. nr.
	Cat. nr.	Ref. nr.	Cat. nr.	Ref. nr.				
50kA FGN	250	FGN36KA250LKF	434073	FGN46KA250LKF	436159			
	350	FGN36KA350LLF	434483	FGN46KA350LLF	434510			
	400	FGN36KA400LLF	436156	FGN46KA400LLF	436160			
80kA FGH	250	FGH36KA250LKF	436150	FGH46KA250LKF	434041			
	350	FGH36KA350LLF	434393	FGH46KA350LLF	434420			
	400	FGH36KA400LLF	436151	FGH46KA400LLF	434042			
150kA FGL	250	FGL36KA250LKF	434049	FGL46KA250LKF	436153			
	350	FGL36KA350LLF	434438	FGL46KA350LLF	434468			
	400	FGL36KA400LLF	434050	FGL46KA400LLF	436154			

One code covers: A standard fixed front connection breaker + Assembled trip unit + Toggle Elongator + Filler for extension module and battery socket + Breaker finishing covers + Fixation hardware

LT: $I_r = 0.64 \cdot I_n$
LTD: Line & Motor; 8 options

Adjustable LT & LTD settable Rating Plugs for Trip Units SMR2

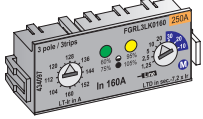

In (A)	3 pole 3 trips	4 pole 3 trips ⁽¹⁾	4 pole 4 trips ⁽¹⁾	4 pole 3.5 trips (N=50%) ⁽¹⁾					
250A	160	FGRL3LK0160	436162	FGRL4LK0160	434101	FGRL4LK0160	434109	FGRL45LK0160	434105
	250	FGRL3LK0250	434098	FGRL43LK0250	436177	FGRL4LK0250	436181	FGRL45LK0250	434106
350A	250	FGRL3LL0250	435399	FGRL43LL0250	435410	FGRL4LL0250	435433	FGRL45LL0250	434495
	350	FGRL3LL0350	435400	FGRL43LL0350	435412	FGRL4LL0350	435302	FGRL45LL0350	435266
400A	400 ⁽²⁾	FGRL3LL0400	434099	FGRL43LL0400	436178	FGRL4LL0400	434111	FGRL45LL0400	434107

Modular Electronic Trip Unit (SMR2) with two adjustable Rating Plugs, setting 0.4 - 1 x In

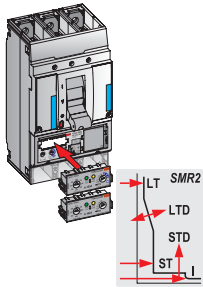

In (A)	3 pole 3 trips	4 pole 3 trips ⁽¹⁾	4 pole 4 trips ⁽¹⁾	4 pole 3.5 trips (N=50%) ⁽¹⁾					
50kA FGN	400 ⁽²⁾	FGN36VA400LLF	435140	FGN436VA400LLF	435152	FGN46VA400LLF	435170	FGN456VA400LLF	435164
80kA FGH	400 ⁽²⁾	FGH36VA400LLF	434953	FGH436VA400LLF	434960	FGH46VA400LLF	434983	FGH456VA400LLF	434971
150kA FGL	400 ⁽²⁾	FGL36VA400LLF	435065	FGL436VA400LLF	435077	FGL46VA400LLF	435128	FGL456VA400LLF	435095

One code covers: A standard fixed front connection breaker + Assembled trip unit + Toggle elongator + Two rating plugs + Filler for extension module and battery socket + Breaker finishing covers + Fixation hardware

Extension modules for the SMR2 Electronic trip unit Plug in types replacing the filler module (1 pc max.)

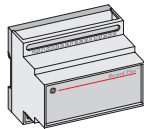
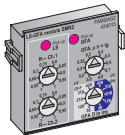
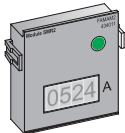

Ammeter with 4 digit LCD display	FAMAM2	436183
Groundfault alarm + Modbus communication (RTu)	FAMGAM2	436185
Groundfault alarm + 2 channel load shedding device	FAMGAS2	436186
Groundfault alarm + Fault type indicators	FAMGAT2	436187
Groundfault protection + Modbus communication (RTu)	FAMGFM2	436188
Groundfault protection + 2 channel load shedding device	FAMGFS2	436189
Groundfault protection + Fault type indicators	FAMGFT2	436190
2 channel load shedding device + Modbus communication (RTu)	FAMSM2	436192
2 channel load shedding device + Fault type indicators	FAMST2	436197
Fault type indicators + Modbus communication (RTu)	FAMMT2	436191
Infra-red read out module	FAI	436723
Spare filler module	FAMB2	434448

One code covers: A plug in module and where needed connection hardware

Other Modules

External contact module (4 contacts, 1A/400V)	FAMECM	434013
---	--------	--------

One code covers: Module and connection hardware

Non-Automatic Circuit Breaker (Switch)

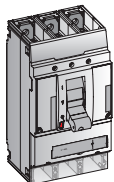

In (A)	3 pole	4 pole ⁽¹⁾		
400	FGY306D400LF	431659	FGY406D400LF	431671

One code covers: A standard fixed front connection breaker + Assembled trip unit + Toggle elongator + Breaker finishing covers + Fixation hardware

(1) Neutral on the left. If neutral on the right is needed, please contact us.
(2) 400A type, line protection only

FG630 - Complete Circuit Breaker

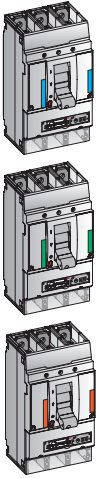

Selective Electronic Trip Unit (SMR1) without Rating Plug

In (A)	3 pole		4 pole ⁽¹⁾		Cat. nr.	Ref. nr.	Cat. nr.	Ref. nr.
	Cat. nr.	Ref. nr.	Cat. nr.	Ref. nr.				
50kA FGN	400	FGN36AA400NLF	434561	FGN46AA400NLF	434636			
	500	FGN36AA500NNF	434812	FGN46AA500NNF	434866			
	630	FGN36AA630NNF	431461	FGN46AA630NNF	431539			
80kA FGH	400	FGH36AA400NLF	433142	FGH46AA400NLF	434432			
	500	FGH36AA500NNF	434600	FGH46AA500NNF	434630			
	630	FGH36AA630NNF	431038	FGH46AA630NNF	431132			
150kA FGL	400	FGL36AA400NLF	434459	FGL46AA400NLF	434534			
	500	FGL36AA500NNF	434645	FGL46AA500NNF	434770			
	630	FGL36AA630NNF	431249	FGL46AA630NNF	431333			

One code covers: A standard fixed front connection breaker + Assembled trip unit + Toggle Elongator + Breaker finishing covers + Fixation hardware

Type line 0.64 - 1 x In

Adjustable Rating Plugs for Trip Units SMR1

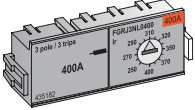

In (A)	3 pole 3 trips	4 pole 3 trips ⁽¹⁾	4 pole 4 trips ⁽¹⁾	4 pole 3.5 trips (N=50%) ⁽¹⁾
400A	250	FGRJ3NL0250 433148	FGRJ43NL0250 433160	FGRJ4NL0250 433184
	400	FGRJ3NL0400 435182	FGRJ43NL0400 435188	FGRJ4NL0400 435200
630A	400	FGRJ3NN0400 433154	FGRJ43NN0400 433166	FGRJ4NN0400 433190
	630	FGRJ3NN0630 433157	FGRJ43NN0630 433169	FGRJ4NN0630 433193

Type line/Motor 0.4 - 1 x In

Switchable Rating Plugs for Trip Units SMR1

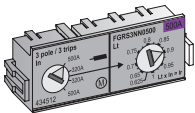

In (A)	3 pole 3 trips	4 pole 3 trips ⁽¹⁾	4 pole 4 trips ⁽¹⁾	4 pole 3.5 trips (N=50%) ⁽¹⁾
400A	400	FGRS3NL0400 433235	FGRS43NL0400 433241	FGRS4NL0400 433253
500A	500	FGRS3NN0500 434512	FGRS43NN0500 434521	FGRS4NN0500 434542

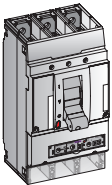

Selective Electronic Trip Unit (SMR1) with switchable Rating Plug

In (A)	3 pole 3 trips	4 pole 3 trips ⁽¹⁾	4 pole 4 trips ⁽¹⁾	4 pole 3.5 trips (N=50%) ⁽¹⁾
50kA FGN	400	FGN36SA400NLF 431530	FGN436SA400NLF 431596	FGN46SA400NLF 431650
	500	FGN36SA500NNF 434835	FGN436SA500NNF 434848	FGN46SA500NNF 434884
80kA FGH	400	FGH36SA400NLF 431091	FGH436SA400NLF 431168	FGH46SA400NLF 431240
	500	FGH36SA500NNF 434612	FGH436SA500NNF 434621	FGH46SA500NNF 434642
150kA FGL	400	FGL36SA400NLF 431309	FGL436SA400NLF 431372	FGL46SA400NLF 431449
	500	FGL36SA500NNF 434657	FGL436SA500NNF 434758	FGL46SA500NNF 434806

One code covers: A standard fixed front connection breaker + Assembled trip unit + Toggle elongator + Rating plug + Breaker finishing covers + Fixation hardware

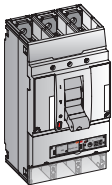
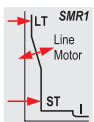

Selective Electronic Trip Unit (SMR1) with Rating Plug, without Overload (LT) protection (Motor)

In (A)	3 pole 3 trips	4 pole 3 trips ⁽¹⁾
50kA FGN	500	FGN36BM500NNF 434690
	500	FGH36BM500NNF 434666
80kA FGH	500	FGL36BM500NNF 434678
	500	FGL436BM500NNF 434684

One code covers: A standard fixed front connection breaker + Assembled trip unit + Toggle elongator + Rating plug + Breaker finishing covers + Fixation hardware

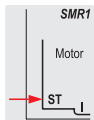

(1) Neutral on the left. If neutral on the right is needed, please contact us.

FG630 - Complete Circuit Breaker

Modular Electronic Trip Unit (SMR2) without Rating Plug

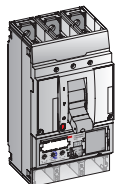

In (A)	3 pole		4 pole ⁽¹⁾		Cat. nr.	Ref. nr.	Cat. nr.	Ref. nr.
	Cat. nr.	Ref. nr.	Cat. nr.	Ref. nr.				
50kA FGN	400	FGN36KA400NLF	436157	FGN46KA400NLF	436161			
	500	FGN36KA500NNF	434824	FGN46KA500NNF	434872			
	630	FGN36KA630NNF	436158	FGN46KA630NNF	434092			
80kA FGH	400	FGH36KA400NLF	436152	FGH46KA400NLF	434043			
	500	FGH36KA500NNF	434606	FGH46KA500NNF	434633			
	630	FGH36KA630NNF	434028	FGH46KA630NNF	434044			
150kA FGL	400	FGL36KA400NLF	434051	FGL46KA400NLF	436155			
	500	FGL36KA500NNF	434651	FGL46KA500NNF	434782			
	630	FGL36KA630NNF	434052	FGL46KA630NNF	434068			

One code covers: A standard fixed front connection breaker + Assembled trip unit + Toggle Elongator + Filler for extension module and battery socket + Breaker finishing covers + Fixation hardware

LT: $I_r = 0.64 - 1 \times I_n$
LTD: Line & Motor; 8 options

Adjustable LT & LTD settable Rating Plugs for Trip Units SMR2

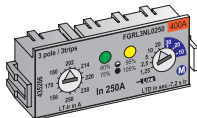

In (A)	3 pole 3 trips	4 pole 3 trips ⁽¹⁾	4 pole 4 trips ⁽¹⁾	4 pole 3.5 trips (N=50%) ⁽¹⁾					
400A	250	FGRL3NL0250	435206	FGRL43NL0250	435218	FGRL4NL0250	435254	FGRL45NL0250	435230
	400	FGRL3NL0400	435212	FGRL43NL0400	435224	FGRL4NL0400	435260	FGRL45NL0400	435236
500A	400	FGRL3NN0400	434471	FGRL43NN0400	435419	FGRL4NN0400	434501	FGRL45NN0400	434497
	500	FGRL3NN0500	434473	FGRL43NN0500	435427	FGRL4NN0500	435309	FGRL45NN0500	435272
630A	630 ⁽²⁾	FGRL3NN0630	434100	FGRL43NN0630	436179	FGRL4NN0630	434112	FGRL45NN0630	436180

Modular Electronic Trip Unit (SMR2) with two Adjustable Rating Plugs, setting 0.4 - 1 x In

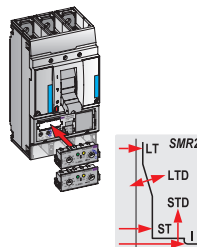

In (A)	3 pole 3 trips	4 pole 3 trips ⁽¹⁾	4 pole 4 trips ⁽¹⁾	4 pole 3.5 trips (N=50%) ⁽¹⁾					
50kA FGN	630 ⁽²⁾	FGN36VA630NNF	435146	FGN436VA630NNF	435158	FGN46VA630NNF	435176	FGN456VA630NNF	435167
80kA FGH	630 ⁽²⁾	FGH36VA630NNF	434958	FGH436VA630NNF	434965	FGH46VA630NNF	435003	FGH456VA630NNF	434977
150kA FGL	630 ⁽²⁾	FGL36VA630NNF	435071	FGL436VA630NNF	435091	FGL46VA630NNF	435134	FGL456VA630NNF	435122

One code covers: A standard fixed front connection breaker + Assembled trip unit + Toggle elongator + Two rating plugs + Filler for extension module and battery socket + Breaker finishing covers + Fixation hardware

Extension modules for the SMR2 Electronic trip unit Plug in types replacing the filler module (1 pc max.)

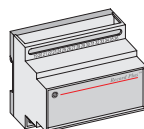
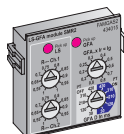
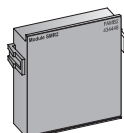

Ammeter with 4 digit LCD display	FAMAM2	436183
Groundfault alarm + Modbus communication	FAMGAM2	436185
Groundfault alarm + 2 channel load shedding device	FAMGAS2	436186
Groundfault alarm + Fault type indicators	FAMGAT2	436187
Groundfault protection + Modbus communication	FAMGFM2	436188
Groundfault protection + 2 channel load shedding device	FAMGFS2	436189
Groundfault protection + Fault type indicators	FAMGFT2	436190
2 channel load shedding device + Modbus communication	FAMSM2	436192
2 channel load shedding device + Fault type indicators	FAMST2	436197
Fault type indicators + Modbus communication	FAMMT2	436191
Infra-red read out module	FAI	436723
Spare filler module	FAMB2	434448

One code covers: A plug in module and where needed connection hardware

Other Modules

External contact module (4 contacts, 1 A/400V)	FAMECM	434013
--	--------	--------

One code covers: Module and connection hardware

Non-Automatic Circuit Breaker (Switch)



In (A)	3 pole	4 pole ⁽¹⁾		
630	FGY306D630NF	431665	FGY406D630NF	431687

One code covers: A standard fixed front connection breaker + Assembled trip unit + Toggle elongator + Breaker finishing covers + Fixation hardware

(1) Neutral on the left. If neutral on the right is needed, please contact us.
(2) Motor protection mode limited to 500A.

FG400 - Circuit Breaker in components

Breaker frame without Trip Unit

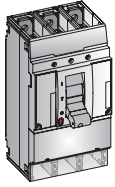

In (A)	3 pole			4 pole ⁽¹⁾		Cat. nr.	Ref. nr.	Cat. nr.	Ref. nr.
	Cat. nr.	Ref. nr.	Cat. nr.	Ref. nr.					
50kA FGN	250	FGN306F250LF	434247	FGN406F250LF	434250				
	400	FGN306F400LF	431473	FGN406F400LF	431548				
80kA FGH	250	FGH306F250LF	434231	FGH406F250LF	434234				
	400	FGH306F400LF	431050	FGH406F400LF	431150				
150kA FGL	250	FGL306F250LF	434239	FGL406F250LF	434242				
	400	FGL306F400LF	431261	FGL406F400LF	431351				

One code covers: A standard fixed front connection breaker with current sensors + Toggle Elongator + Breaker finishing covers + Fixation hardware

Selective Electronic Trip Unit (SMR1) without Rating Plug

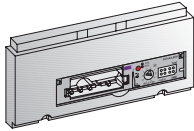

In (A)	3 pole			4 pole ⁽¹⁾		Long time protection Two long time delay bands (with choice of protection mode) Short time protection	Adj. Ir= 0.4 - 1 x In Line, no phase loss protection Motor with phase loss protection Adj. 2 - 13 x Ir (current dependant delay) ⁽²⁾ Fixed 14 x Is ⁽²⁾
	Cat. nr.	Ref. nr.	Cat. nr.	Ref. nr.			
250	FGTAA3L0250	434319	FGTAA4L0250	434323			
350	FGTAA3L0350	434890	FGTAA4L0350	434896			
400 ⁽³⁾	FGTAA3L0400	431718	FGTAA4L0400	431742			

Instantaneous protection

Type line 0.64 - 1 x In

Adjustable Rating Plugs for Trip Units SMR1

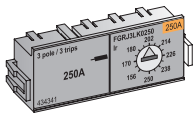

In (A)	In (A)	3 pole 3 trips		4 pole 3 trips ⁽¹⁾		4 pole 4 trips ⁽¹⁾		4 pole 3.5 trips (N=50%) ⁽¹⁾	
		Cat. nr.	Ref. nr.	Cat. nr.	Ref. nr.	Cat. nr.	Ref. nr.	Cat. nr.	Ref. nr.
250A	160	FGRJ3LK0160	434337	FGRJ43LK0160	434345	FGRJ4LK0160	434361	FGRJ45LK0160	434353
	250	FGRJ3LK0250	434341	FGRJ43LK0250	434349	FGRJ4LK0250	434365	FGRJ45LK0250	434357
400A	250	FGRJ3LL0250	435343	FGRJ43LL0250	435356	FGRJ4LL0250	435397	FGRJ45LL0250	435367
	400 ⁽³⁾	FGRJ3LL0400	433151	FGRJ43LL0400	433163	FGRJ4LL0400	433187	FGRJ45LL0400	433175

Type line/Motor 0.4 - 1 x In

Switchable Rating Plugs for Trip Units SMR1

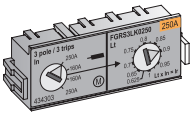

In (A)	In (A)	3 pole 3 trips		4 pole 3 trips ⁽¹⁾		4 pole 4 trips ⁽¹⁾		4 pole 3.5 trips (N=50%) ⁽¹⁾	
		Cat. nr.	Ref. nr.	Cat. nr.	Ref. nr.	Cat. nr.	Ref. nr.	Cat. nr.	Ref. nr.
250A	250	FGRS3LK0250	434303	FGRS43LK0250	434307	FGRS4LK0250	434315	FGRS45LK0250	434311
350A	350	FGRS3LL0350	435435	FGRS43LL0350	434516	FGRS4LL0350	434537	FGRS45LL0350	434525

Modular Electronic Trip Unit (SMR2) without Rating Plug

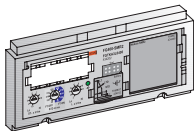

In (A)	3 pole			4 pole ⁽¹⁾		Long time protection Eight long time delay bands	Adj. Ir= 0.4 - 1 x In 5 for line, no phase loss protection 3 for motor with phase loss protection ⁽³⁾ Adj. 2 - 13 x Ir ⁽²⁾
	Cat. nr.	Ref. nr.	Cat. nr.	Ref. nr.			
250	FGTKA3L0250	434201	FGTKA4L0250	434205			
350	FGTKA3L0350	434902	FGTKA4L0350	434908			
400 ⁽³⁾	FGTKA3L0400	434202	FGTKA4L0400	434261			

Short time protection
Switchable to I²t curve
Five short time delay bands
Instantaneous protection

From 30 to 410 milliseconds
Adj. 2 - 14 x Is⁽²⁾

LT: Ir = 0.64 - 1 x In LTD: Line & Motor; 8 options

Adjustable LT & LTD settable Rating Plugs for Trip Units SMR2

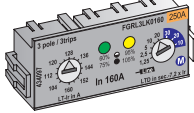

In (A)	In (A)	3 pole 3 trips		4 pole 3 trips ⁽¹⁾		4 pole 4 trips ⁽¹⁾		4 pole 3.5 trips (N=50%) ⁽¹⁾	
		Cat. nr.	Ref. nr.	Cat. nr.	Ref. nr.	Cat. nr.	Ref. nr.	Cat. nr.	Ref. nr.
250A	160	FGRL3LK0160	436162	FGRL43LK0160	434101	FGRL4LK0160	434109	FGRL45LK0160	434105
	250	FGRL3LK0250	434098	FGRL43LK0250	436177	FGRL4LK0250	436181	FGRL45LK0250	434106
350A	250	FGRL3LL0250	435399	FGRL43LL0250	435410	FGRL4LL0250	435433	FGRL45LL0250	434495
	350	FGRL3LL0350	435400	FGRL43LL0350	435412	FGRL4LL0350	435302	FGRL45LL0350	435266
400A	400 ⁽³⁾	FGRL3LL0400	434099	FGRL43LL0400	436178	FGRL4LL0400	434111	FGRL45LL0400	434107

(1) Neutral on the left. If neutral on the right is needed, please contact us.

(2) 400A trip unit limited to a maximum short time setting of 10 x Ir (adjusted LT current), and an instantaneous setting of 11x Is. (sensor rating)

(3) 400A trip unit not configured for motor protection.

FG630 - Circuit Breaker in Components

Breaker frame without Trip Unit

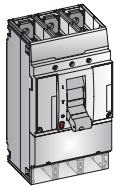

50kA FGN	In (A)	3 pole		4 pole ⁽¹⁾		Cat. nr.	Ref. nr.	Cat. nr.	Ref. nr.
		Cat. nr.	Ref. nr.	Cat. nr.	Ref. nr.				
400	400	FGN306F400NF	431488	FGN406F400NF	431554				
	630	FGN306F630NF	431491	FGN406F630NF	431560				
80kA FGH	400	FGH306F400NF	431067	FGH406F400NF	431153				
	630	FGH306F630NF	431073	FGH406F630NF	431156				
150kA FGL	400	FGL306F400NF	431267	FGL406F400NF	431354				
	630	FGL306F630NF	431282	FGL406F630NF	431357				
One code covers: A standard fixed front connection breaker with current sensors + Toggle Elongator + Breaker finishing covers + Fixation hardware									

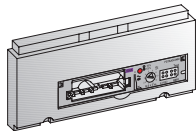

Selective Electronic Trip Unit (SMR1) without Rating Plug

SMR1	In (A)	3 pole		4 pole ⁽¹⁾		Long time protection Two long time delay bands (with choice of protection mode) Short time protection Instantaneous protection	Adj. Ir= 0.4 - 1 x In Line, no phase loss protection Motor with phase loss protection Adj. 2 - 13 x Ir (current dependant delay) ⁽²⁾ Fixed 14 x Is ⁽²⁾
		Cat. nr.	Ref. nr.	Cat. nr.	Ref. nr.		
400	400	FGTAA3N0400	431721	FGTAA4N0400	431745		
	500	FGTAA3N0500	434893	FGTAA4N0500	434899		
	630	FGTAA3N0630	431736	FGTAA4N0630	431748		

Type line 0.64 - 1 x In

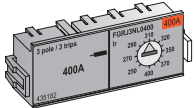

Adjustable Rating Plugs for Trip Units SMR1

400A	In (A)	3 pole 3 trips		4 pole ⁽¹⁾		4 pole 4 trips ⁽¹⁾		4 pole 3.5 trips (N=50%) ⁽¹⁾	
		Cat. nr.	Ref. nr.	Cat. nr.	Ref. nr.	Cat. nr.	Ref. nr.	Cat. nr.	Ref. nr.
400A	250	FGRJ3NL0250	433148	FGRJ43NL0250	433160	FGRJ4NL0250	433184	FGRJ45NL0250	433172
	400	FGRJ3NL0400	435182	FGRJ43NL0400	435188	FGRJ4NL0400	435200	FGRJ45NL0400	435194
630A	400	FGRJ3NN0400	433154	FGRJ43NN0400	433166	FGRJ4NN0400	433190	FGRJ45NN0400	433178
	630	FGRJ3NN0630	433157	FGRJ43NN0630	433169	FGRJ4NN0630	433193	FGRJ45NN0630	433181

Type line/Motor 0.4 - 1 x In

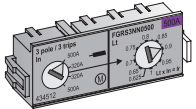

Switchable Rating Plugs for Trip Units SMR1

400A	In (A)	3 pole 3 trips		4 pole ⁽¹⁾		4 pole 4 trips ⁽¹⁾		4 pole 3.5 trips (N=50%) ⁽¹⁾	
		Cat. nr.	Ref. nr.	Cat. nr.	Ref. nr.	Cat. nr.	Ref. nr.	Cat. nr.	Ref. nr.
400A	400	FGRS3NL0400	433235	FGRS43NL0400	433241	FGRS4NL0400	433253	FGRS45NL0400	433247
	500	FGRS3NN0500	434512	FGRS43NN0500	434521	FGRS4NN0500	434542	FGRS45NN0500	434530

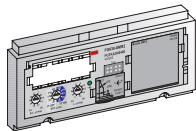

Modular Electronic Trip Unit (SMR2) without Rating Plug

SMR2	In (A)	3 pole		4 pole 3 trips ⁽¹⁾		Long time protection Eight long time delay bands Short time protection Switchable to I ² t curve Five short time delay bands Instantaneous protection	Adj. Ir= 0.4 - 1 x In 5 for line, no phase loss protection 3 for motor with phase loss protection ⁽³⁾ Adj. 2 - 13 x Ir ⁽²⁾ From 30 to 410 milliseconds Adj. 2 - 14 x Is ⁽²⁾
		Cat. nr.	Ref. nr.	Cat. nr.	Ref. nr.		
400	400	FGTKA3N0400	434203	FGTKA4N0400	434263		
	500	FGTKA3N0500	434905	FGTKA4N0500	434911		
	630	FGTKA3N0630	434204	FGTKA4N0630	434265		

LT: Ir = 0.64 - 1 x In LTD: Line & Motor; 8 options

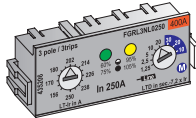

Adjustable LT & LTD settable Rating Plugs for Trip Units SMR2

400A	In (A)	3 pole 3 trips		4 pole 4 trips ⁽¹⁾		4 pole 4 trips ⁽¹⁾		4 pole 3.5 trips (N=50%) ⁽¹⁾	
		Cat. nr.	Ref. nr.	Cat. nr.	Ref. nr.	Cat. nr.	Ref. nr.	Cat. nr.	Ref. nr.
400A	250	FGRL3NL0250	435206	FGRL43NL0250	435218	FGRL4NL0250	435254	FGRL45NL0250	435230
	400	FGRL3NL0400	435212	FGRL43NL0400	435224	FGRL4NL0400	435260	FGRL45NL0400	435236
500A	400	FGRL3NN0400	434471	FGRL43NN0400	435419	FGRL4NN0400	434501	FGRL45NN0400	434497
	500	FGRL3NN0500	434473	FGRL43NN0500	435427	FGRL4NN0500	435309	FGRL45NN0500	435272
630A	630 ⁽³⁾	FGRL3NN0630	434100	FGRL43NN0630	436179	FGRL4NN0630	434112	FGRL45NN0630	436180

Extension modules for the SMR2 Electronic trip unit

Plug in types replacing the filler module (1 pc max.)

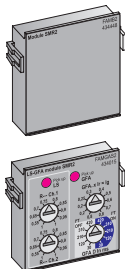

SMR2	Description	Part Number	Ref. nr.
	Ammeter with 4 digit LCD display	FAMAM2	436183
	Groundfault alarm + Modbus communication	FAMGAM2	436185
	Groundfault alarm + 2 channel load shedding device	FAMGAS2	436186
	Groundfault alarm + Fault type indicators	FAMGAT2	436187
	Groundfault protection + Modbus communication	FAMGFM2	436188
	Groundfault protection + 2 channel load shedding device	FAMGFS2	436189
	Groundfault protection + Fault type indicators	FAMGFT2	436190
	2 channel load shedding device + Modbus communication	FAMSM2	436192
	2 channel load shedding device + Fault type indicators	FAMST2	436197
	Fault type indicators + Modbus communication	FAMMT2	436191
	Infra-red read out module	FAI	436723
	Spare filler module	FAMB2	434448
One code covers: A plug in module and where needed connection hardware			

Other Modules

SMR2	External contact module (4 contacts, 1A/400V)	FAMECM	434013
One code covers: Module and connection hardware			

(1) Neutral on the left. If neutral on the right is needed, please contact us.

(2) 630A trip unit limited to a maximum short time setting of 10 x Ir (adjusted LT current), and an instantaneous setting of 11x Is. (sensor rating)

(3) 630A trip unit not configured for motor protection.

FG - Internal Accessories

Contacts

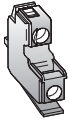

	Normally open		Normally closed		Cat. nr.	Ref. nr.
	Cat. nr.	Ref. nr.	Cat. nr.	Ref. nr.		
Aux. switch right mounted	FAS10R	430837	FAS01R	430831		
Aux. switch left mounted	FAS10L	430834	FAS01L	430828		
Bell alarm electronic trip unit	FABAT10	430818	FABAT01	430815		
Bell alarm mechanism	FABAM10	432003	FABAM01	432000		
Bell alarm RCD device	FABAT10	430818	FABAT01	430815		

Releases

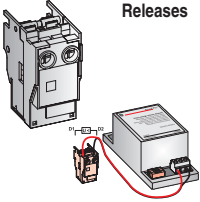

	Shunt		Undervoltage		Delayed undervoltage	
	Cat. nr.	Ref. nr.	Cat. nr.	Ref. nr.	Cat. nr.	Ref. nr.
12V DC	FASHTB	430840	-	-	FAUVDN	430858
24V AC/DC	FASHTD	430843	FAUVRD	430861	-	-
48V AC/DC	FASHTF	430846	FAUVRF	430864	-	-
60V AC/DC	FASHTH	435118	FAUVRH	434120	-	-
110/130V AC/DC	FASHTJ	430849	FAUVRJ	430867	-	-
220/240V AC 250 V DC	FASHTN	430852	FAUVRN	430870	-	-
400/480V AC	FASHTU	430855	FAUVRU	430873	-	-
220/240V AC	-	-	-	-	FAUVDN	430858

FG - Operators

Electrical Operators

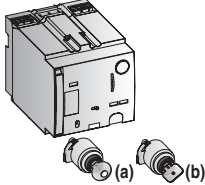

24V AC/DC	FGEMFD	432817				
48V AC/DC	FGEMFF	432820				
60V AC/DC	FGEMFH	432823				
110/127V AC/DC	FGEMFJ	432826				
220/250V AC/DC	FGEMFN	432829				
400/440V AC	FGEMF8	432811				
Keylock for electrical operator Ronis ⁽¹⁾ (a)	FG1BRE	431404				
Keylock for electrical operator Profalux ⁽¹⁾ (b)	FG1BPE	431403				

Rotary Handles

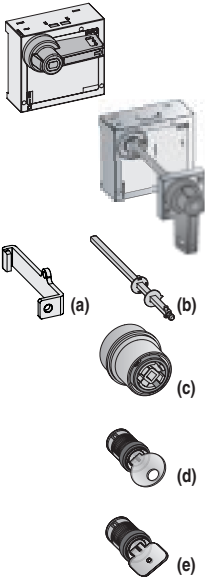

	Direct on device		Rotary handle through door or cover plate ⁽²⁾		Panel or door mounted	
	Cat. nr.	Ref. nr.	Cat. nr.	Ref. nr.	Cat. nr.	Ref. nr.
Grey	FGNRF	432888	FGNRC	432873	-	-
Red	FGNRFV	432891	FGNRCV	432876	-	-
Grey + auxiliary contacts 2xNO ⁽³⁾	-	-	FGNRY	432897	-	-
Red + auxiliary contacts 2xNO ⁽³⁾	-	-	FGNRYV	433409	-	-
Grey (max. 350 mm)	-	-	-	-	FGNRD	432879
Red (max. 350 mm)	-	-	-	-	FGNRDV	432882
Grey + auxiliary contacts 2xNO ⁽³⁾	-	-	-	-	FGNRZ	432900
Red + auxiliary contacts 2xNO ⁽³⁾	-	-	-	-	FGNRZV	432903
Accessories						
Flex operator adaptor push to trip (a)	FGNFT	432867	Only for use with panel or door mounted type			
Extension shaft kit (max. 600 mm) (b)	FGNRE	434735	Only for use with panel or door mounted type			
Adaptor for drawout (c)	FGNRW	433892				
Ronis keylock 1104B nr. BC 1027 ⁽¹⁾ (d)	FA1BR1	430088				
Ronis keylock 1104B nr. BC 1053 ⁽¹⁾ (d)	FA1BR2	430089				
Ronis keylock 1104B nr. BC 2932 ⁽¹⁾ (d)	FA1BR3	430504				
Ronis keylock 1104B nr. BC 2911 ⁽¹⁾ (d)	FA1BR4	430505				
Ronis keylock 1104B nr. BC 2936 ⁽¹⁾ (d)	FA1BR5	430506				
Ronis keylock 1104B nr. BC 2940 ⁽¹⁾ (d)	FA1BR6	430507				
Ronis lock with random key ⁽¹⁾ (d)	FA1BRH	430068				
Profalux lock with random key ⁽¹⁾ (e)	FA1BPH	430813				

FG - Residual Current Devices

RCD Differential Bottom Mounted

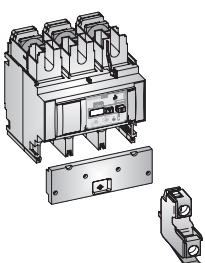

	3 pole		4 pole	
	Cat. nr.	Ref. nr.	Cat. nr.	Ref. nr.
400/630A Voltage 200/440V AC	FGQDB3M	430860	FGQDB4M	430869
400/630A Voltage 400/690V AC	FGQDB3H	430856	FGQDB4H	430865
Normally open				
Bell Alarm RCD device	FABAT10	430818	FABAT 01	430815
One code covers an RCD with: Fixation hardware + Sealable interconnection cover				

(1) Key included
 (2) Add door flange FGFH for door lock options
 (3) On request 1xNO/1xNC is available.



FG - Plug-in System

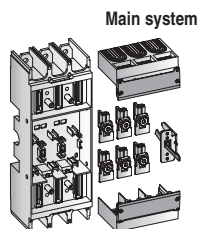

	3 pole		4 pole	
	Cat. nr.	Ref. nr.	Cat. nr.	Ref. nr.
Complete set for breaker	FGDDF3	430944	FGDDF4	431064
Fixed part for breaker	FGDF3	431983	FGDF4	431986
Mobile part for breaker	FGDMP3	432796	FGDMP4	432799
Complete set: Fixed and mobile part with connection and fixation hardware				
Fixed part: Fixed base with connection and fixation and hardware				
Mobile part: Mechanism trip device, terminal shields and set of 3 or 4 pole plugs				
Auxiliary disconnects (Secondary wiring)				
Complete set 8 pole	FAPFM	430824		
Fixed part 8 pole	FAPF8	430823		
Mobile part 8 pole	FAPM8	430826		
Plug and socket 10 pole (side mounted)	FAPPS	430827		
Insertion prevention kit				
Insertion prevention kit (ofwrong A rating)	FAPIP	430825		
Box clamps				
Box clamps Cu/Al set of 3	FGTCA1327	435107	FGTCA230B	
Box clamps Cu/Al set of 4	FGTCA1427	435116	FGTCA240B	

FG - Drawout System

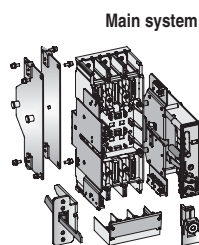

	3 pole		4 pole	
	Cat. nr.	Ref. nr.	Cat. nr.	Ref. nr.
Complete set	FGWS3	432910	FGWS4	432913
One code covers the fixed and withdrawable part of the draw-out system, with plug-in base, mounting accessories and fixation hardware.				
Accessories (for auxiliary disconnects see plug-in system)				
Keylock in draw-out position Ronis ⁽¹⁾ (a)	FG1BRW	433407		
Keylock in draw-out position Profalux ⁽¹⁾ (b)	FG1BPW	433406		
Position indication contact NO (c)	FAS01L	430828		
Position indication contact NC (c)	FAS10L	430834		

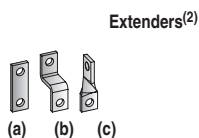

FG - Connections: Optional



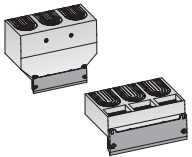
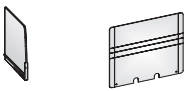
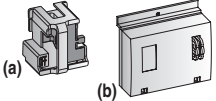

	3 pole		4 pole	
	Cat. nr.	Ref. nr.	Cat. nr.	Ref. nr.
Extenders⁽²⁾				
Standard flat type (a)	FBES3	431696	FBES4	431697
Heightened type (b)	FBEH3	431691	FBEH4	431695
Twisted 90° c	FBEA3	431686	FBEA4	431690
Spreader flat⁽²⁾				
Pole spacing 70mm	FBSS3	431981	FBSS4	431982
Rear Connections⁽²⁾				
Set 3 pole (2 short, 1 long)	FBRC3	431701	FBRC4	
Set 4 pole (2 short, 2 long)				431702
Set 3 pole (3 short)	FBRC3S	432193	FBRC4S	
Set 4 pole (4 short)				432194
Internal Box Clamps⁽²⁾				
Box Clamp Cu/Al, set 3 pole	FGTCA1327	435412	FGTCA230B	433412
Box Clamp Cu/Al, set 4 pole	FGTCA1427	435413	FGTCA240B	433413

(1) Key included
 (2) Set for equipping the line OR load side of breaker.

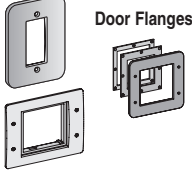
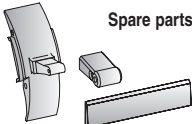
FG - Installation Accessories

	3 pole		4 pole		
	Cat. nr.	Ref. nr.	Cat. nr.	Ref. nr.	
Terminal shields (with finishing covers) 	Long and widened type for spreaders and 690V applications, set of 2 pcs	FGJW3	432861	FGJW4	432864
	Medium, set of 2 pcs.	FGJM3	432846	FGJM4	432849
	Short, set of 2 pcs.	FGJS3	432855	FGJS4	432858
Specific to connection area 	Phase separators, set of 12 pcs	FGJP	432852		
	Backplate (3 or 4pole), set of 2 pcs.	FGJB	432840		
Padlocking devices for toggle operator⁽¹⁾ 	Padlocking removable (a)	FG1PR	431409		
	Padlocking fixed (b)	FG1PF	431408		
Circuit indication / coding 	Set of 20 blank labels	FAC	430821		
Door Flanges 	RCD unit front face for 3 pole and 4 pole	FDFP3	430941		
	Front face toggle area	FGFT	432836		
	Rotary handle (through cover plate model)	FGFH	430545		
	Motor operator	FGFE	430544		
Spare parts 	Finishing covers, set of 2 pcs.	FGUA3	432908	FGUA4	432909
	Spare toggle (set of 5 pieces)	FGUT	433541		

FG - Accessories Electronic Trip Units SMR1 and SMR2

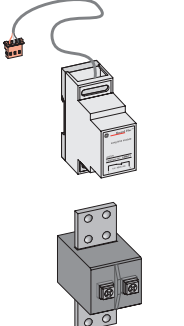
		3 pole		
 (a)	Rating plug tool (SMR1 & 2)	(a) FAR	433500	
	 (b)	Battery test device (SMR1 & 2)	(b) FAT	431402
		Long time module (SMR1 & 2)	(c) FAMLT1	433376
 (d)	Ground Fault SMR2 Sensor 250A	(d) FGGS0250	431870	
	Ground Fault SMR2 Sensor 400A	(d) FGGS0400	432838	
	Ground Fault SMR2 Sensor 630A	(d) FGGS0630	432839	

(1) Padlocks not included

